

Montagehandleiding
Verano Aluminium Jaloezie 70 mm

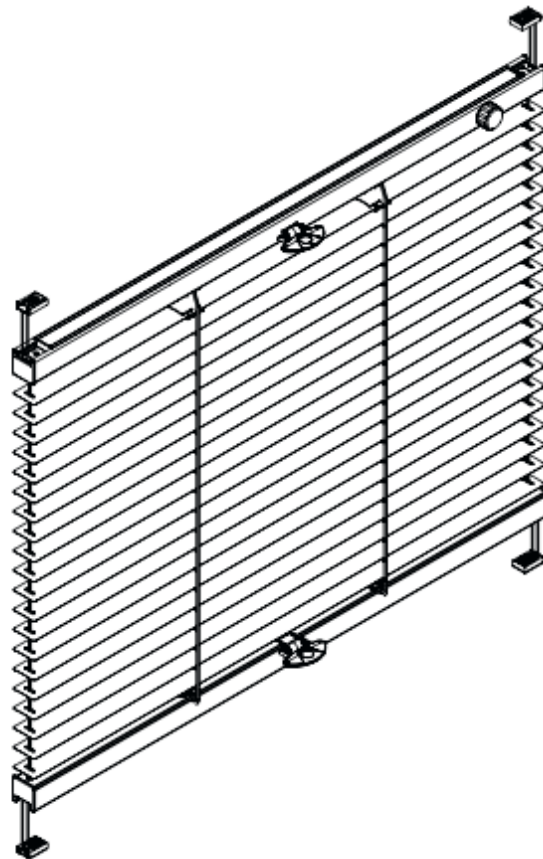

Belangrijk vóór het monteren**Waarschuwing**

Als u het Verano® product zelf monteert, is dat voor uw eigen risico. Gebruik deze instructie slechts als een hulpmiddel en alleen bij montage van dit specifieke Verano® product. Mocht u er zelf niet uitkomen, dan kunt u altijd kiezen voor professionele montage. Het montageteam van uw Verano® dealer staat graag voor u klaar.

Pas op voor beschadigingen! Gebruik geen mes of ander scherp voorwerp bij het openen van de verpakking. De inhoud zou beschadigd kunnen raken. Leg de inhoud op een zachte ondergrond.

Pas op wanneer u gaat boren. Vallend boorgruis kan beschadigingen veroorzaken.

Controleer of het kozijn of de gevel vlak is

Schroeven voor de bevestiging zijn niet bijgesloten. Gebruik altijd schroeven en pluggen welke geschikt zijn voor de wand of het plafond waarop het lamelgordijn gemonteerd wordt!

Montage standaard montagebeugel



16 - 25 mm

35 - 50 - 70 mm

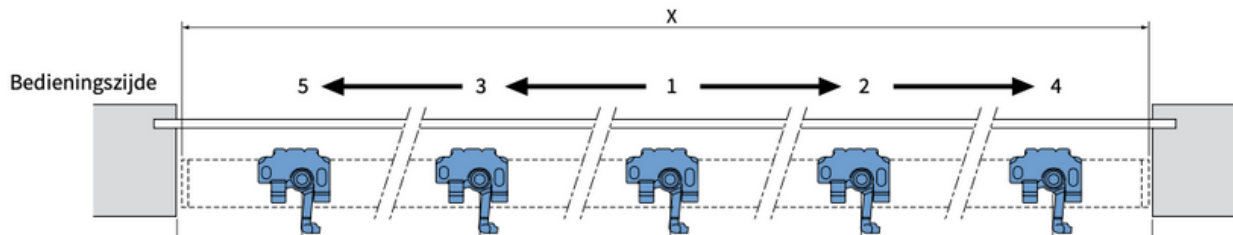
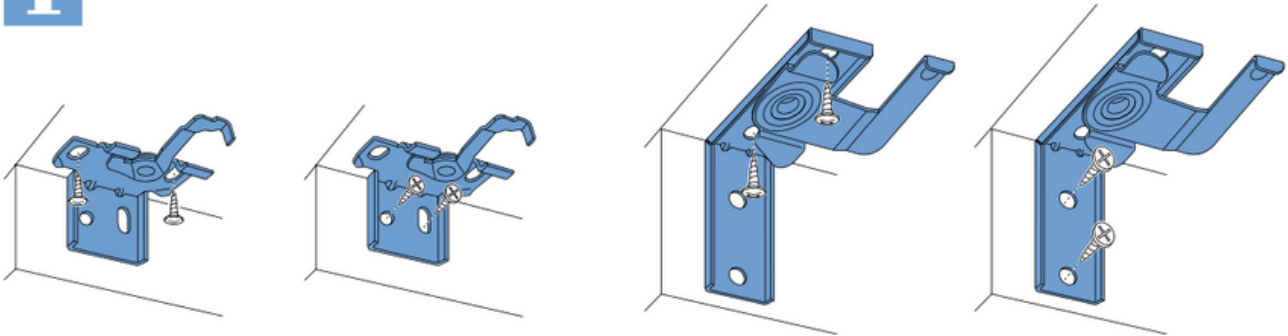

aluminium	16 mm jaloezie	70 - 100 mm	max. 800 mm	max. 800 mm	max. 800 mm	max. 800 mm	max. 70 mm
	25 mm jaloezie	70 - 100 mm	max. 800 mm	max. 800 mm	max. 800 mm	max. 800 mm	max. 70 mm
	35 mm jaloezie	110 mm	max. 800 mm	max. 800 mm	max. 800 mm	max. 800 mm	max. 70 - 120 mm
	50 mm jaloezie	150 mm	max. 800 mm	max. 800 mm	max. 800 mm	max. 800 mm	max. 70 - 150 mm
	70 mm jaloezie	150 mm	max. 800 mm	max. 800 mm	max. 800 mm	max. 800 mm	max. 70 - 150 mm
hout	50 mm jaloezie	150 mm	max. 800 mm	max. 800 mm	max. 800 mm	max. 800 mm	max. 70 - 150 mm
	70 mm jaloezie	150 mm	max. 800 mm	max. 800 mm	max. 800 mm	max. 800 mm	max. 70 - 150 mm

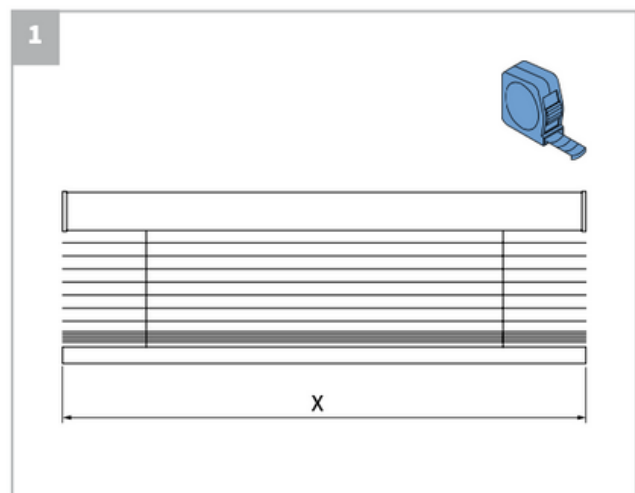
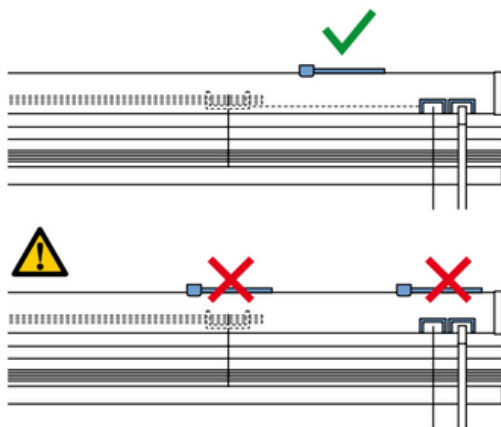

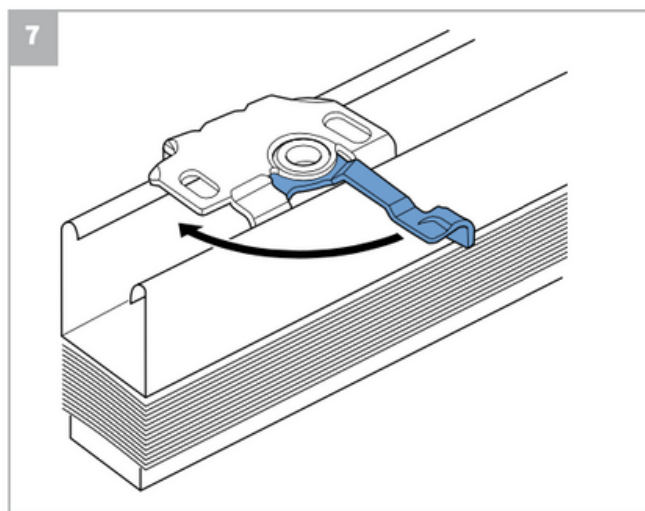
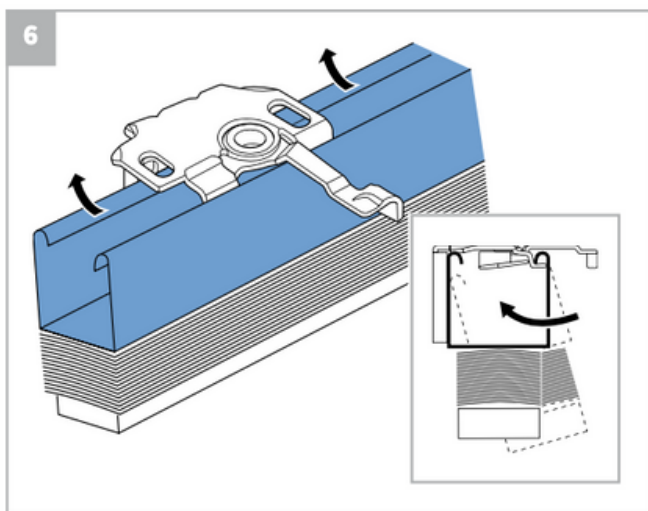
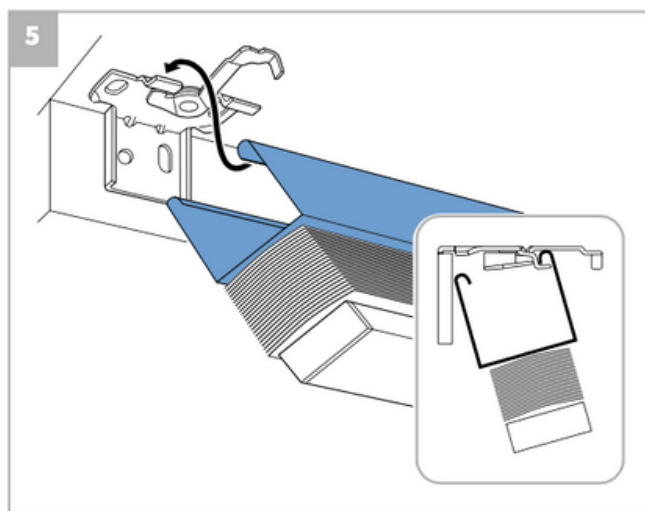
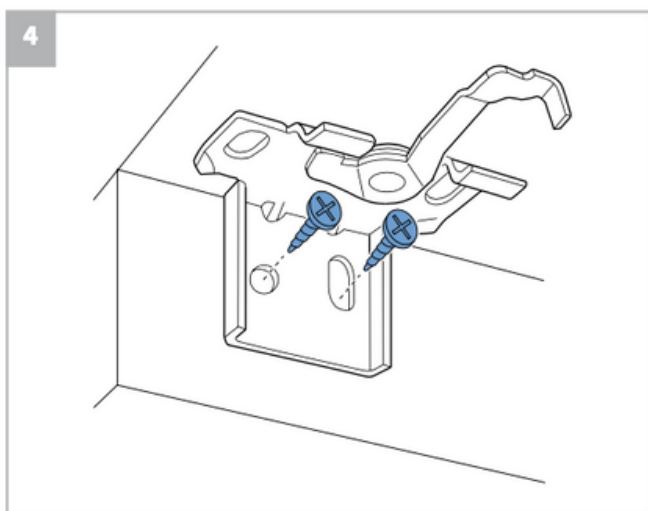
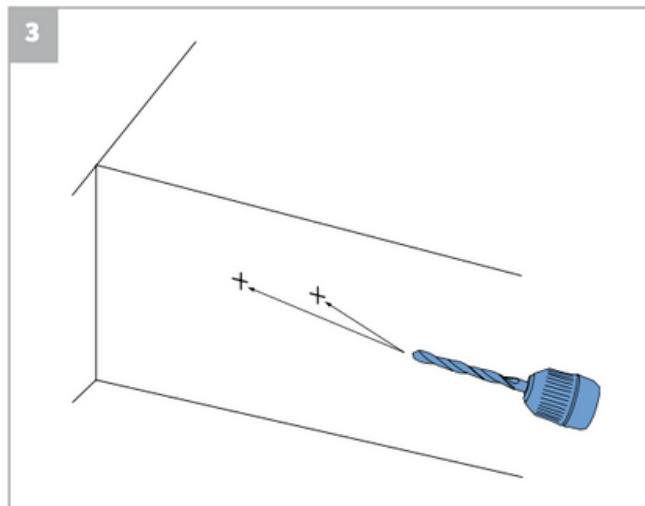
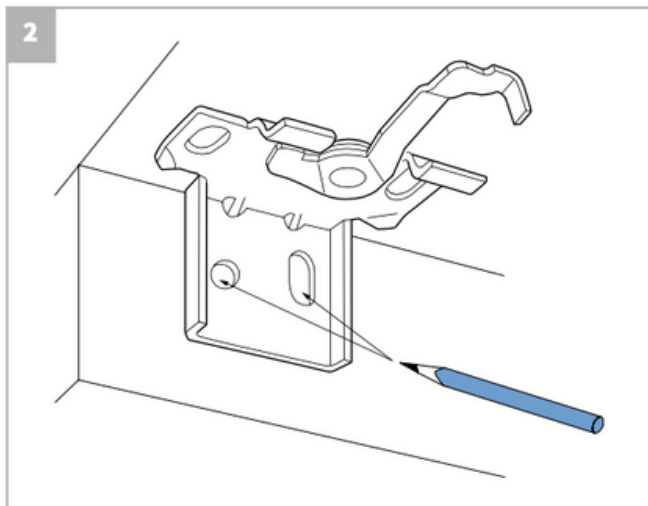

Demontage standaard montagebeugel

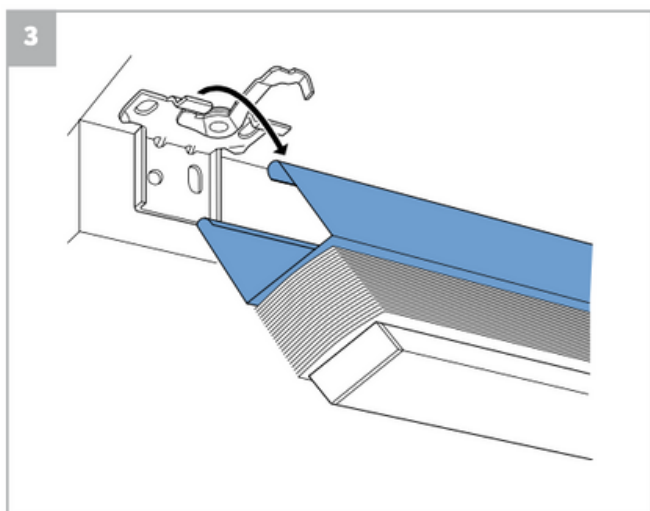
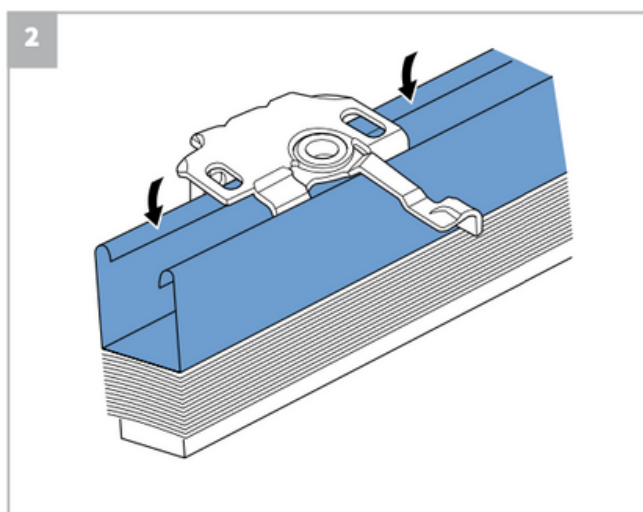
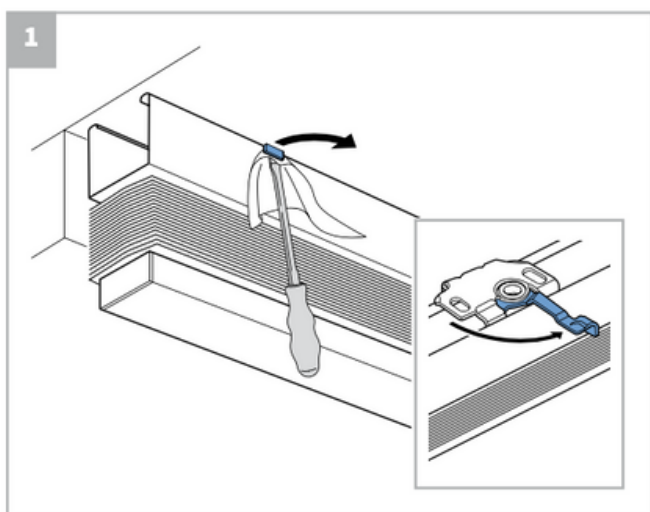

Montage m.b.v. zijsteunen

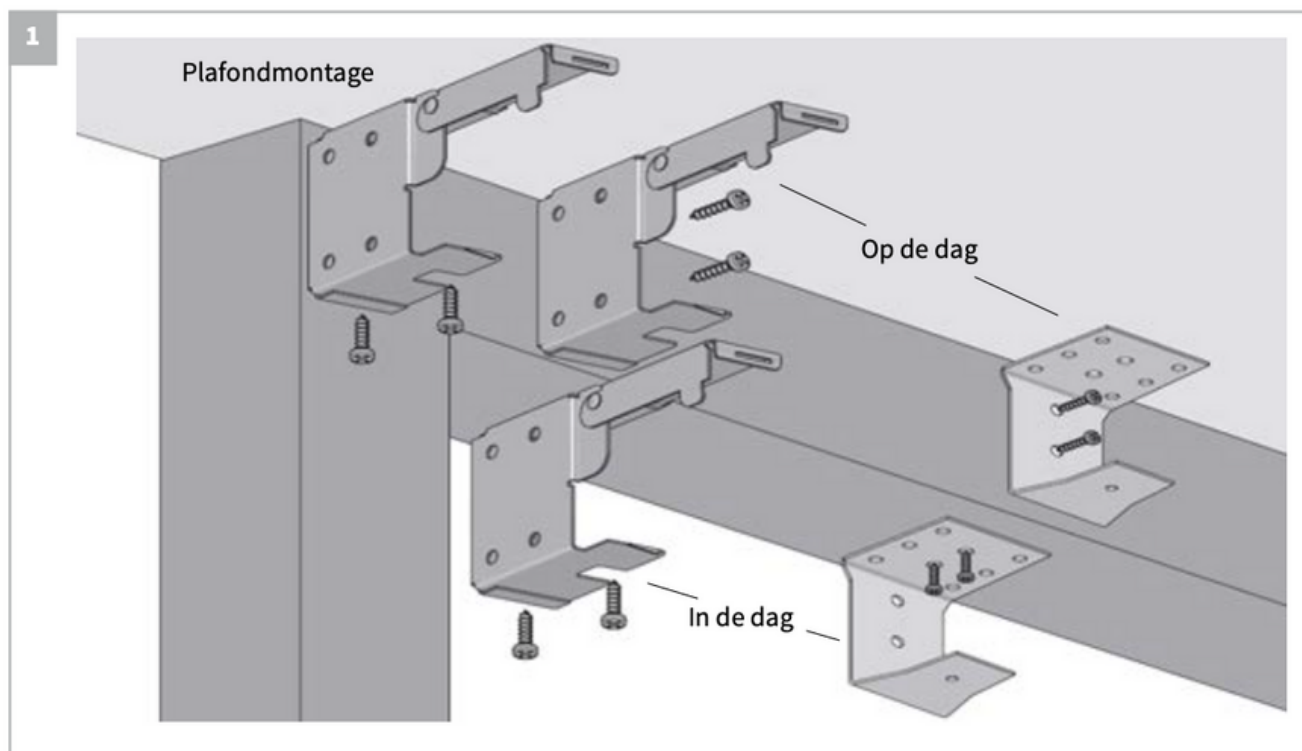
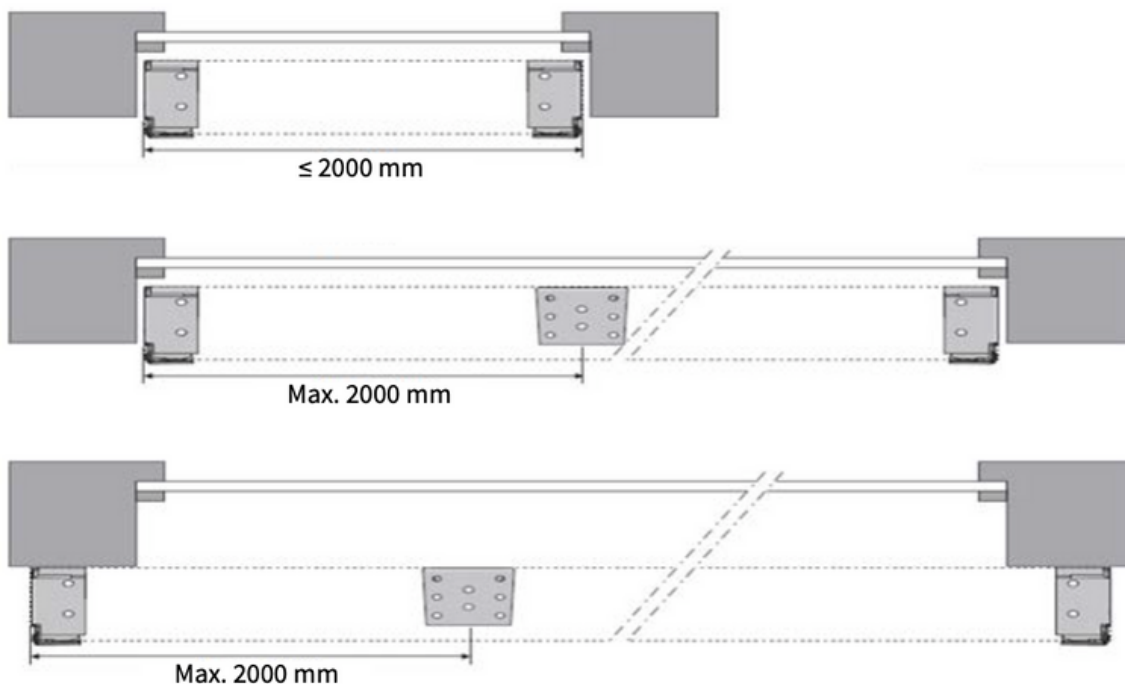

Montage m.b.v. klemsteun op draai/kiepraam

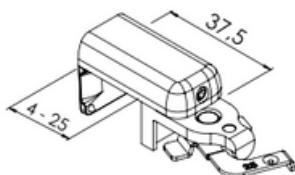

25 mm bovenbak - bovenkant

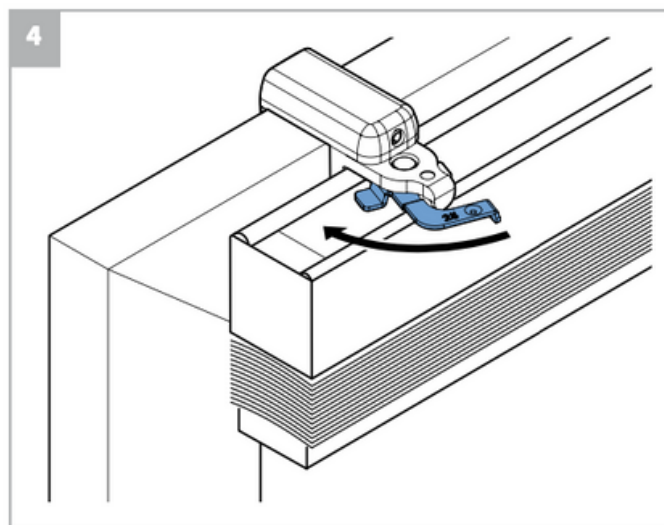
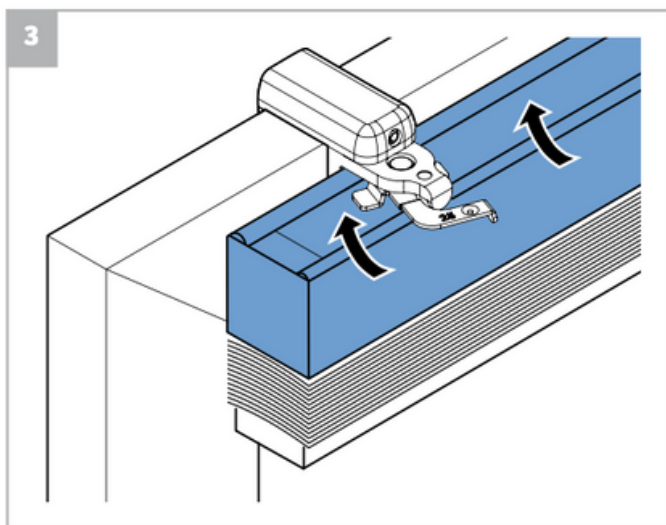
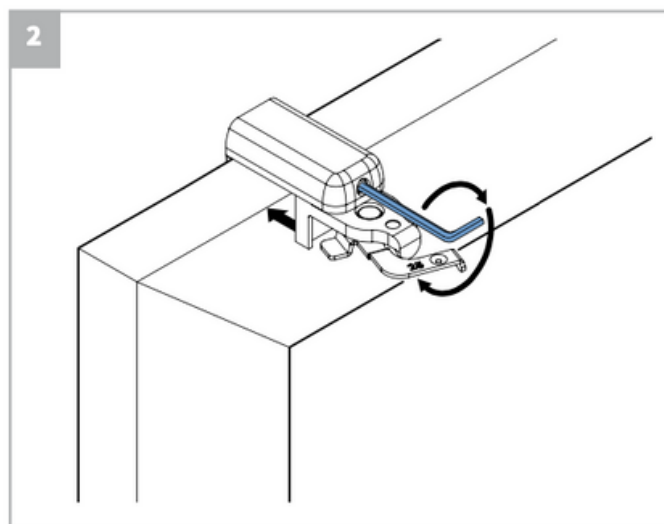
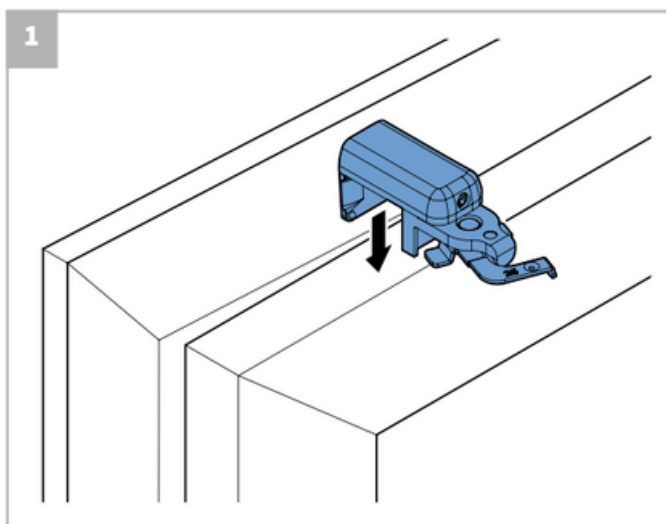

Montage m.b.v. klemsteun op draai/kiepraam met zijgeleiding

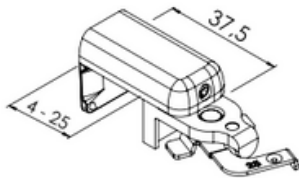

25 mm bovenbak - bovenkant

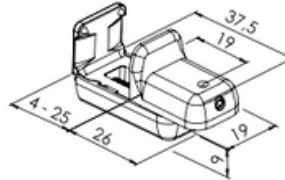

25 mm - onderkant

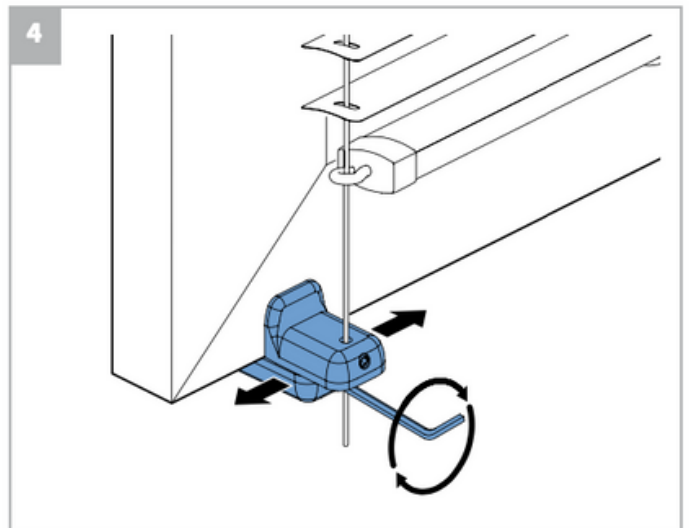
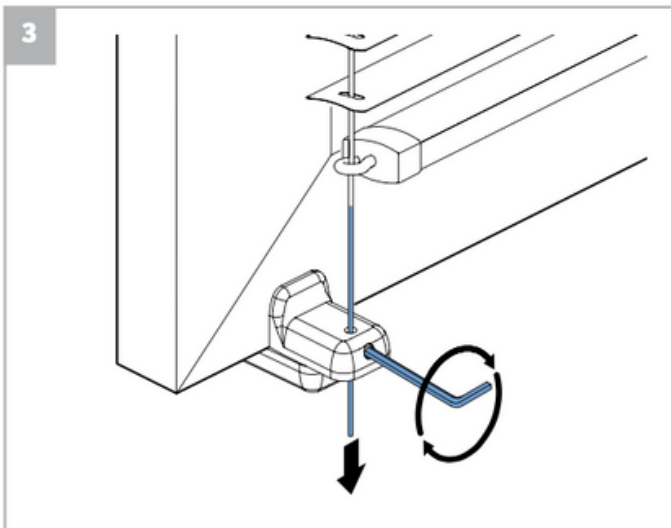
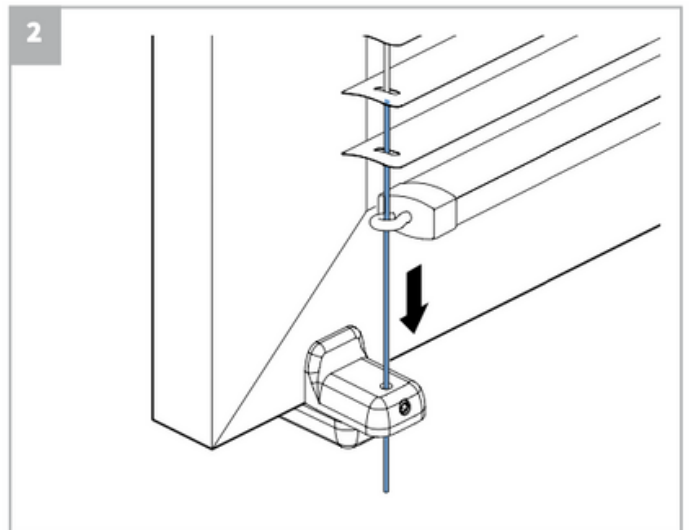
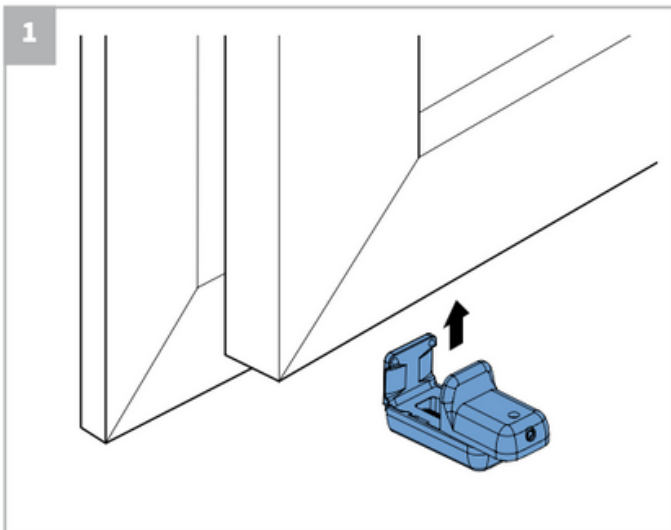

Montage koofsteunen

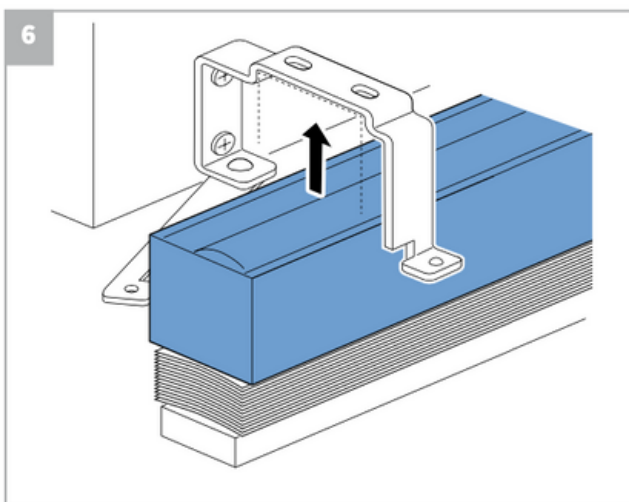
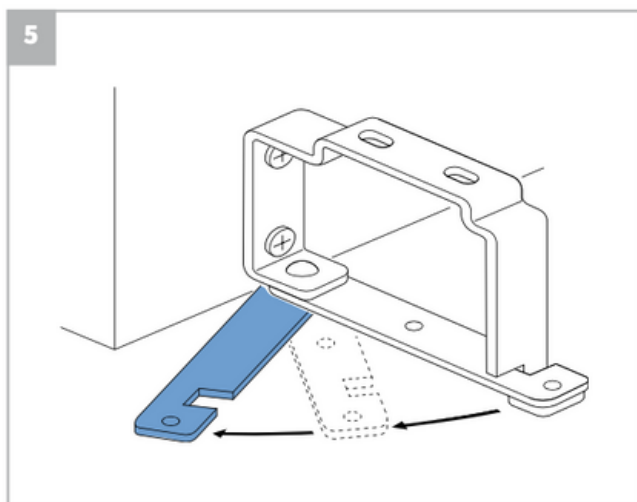
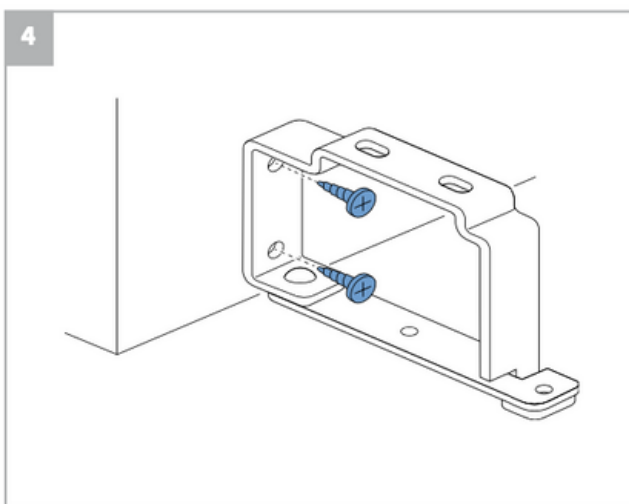
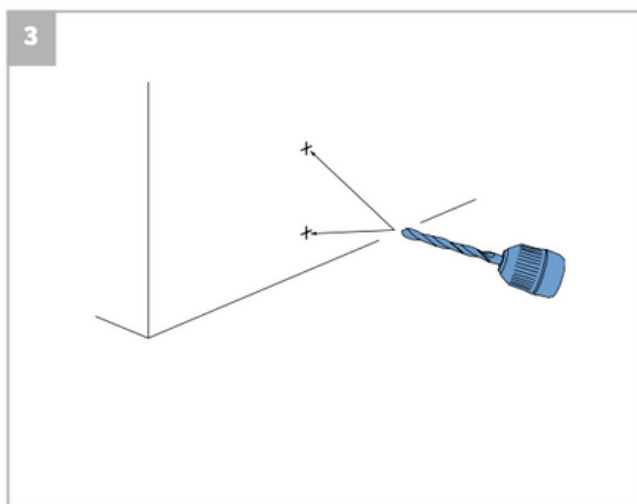
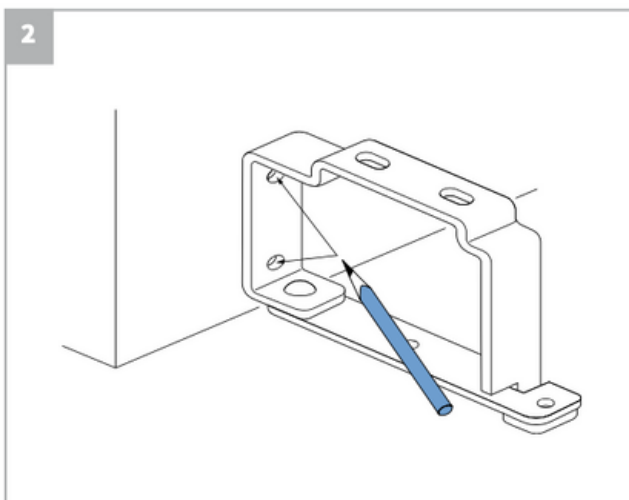
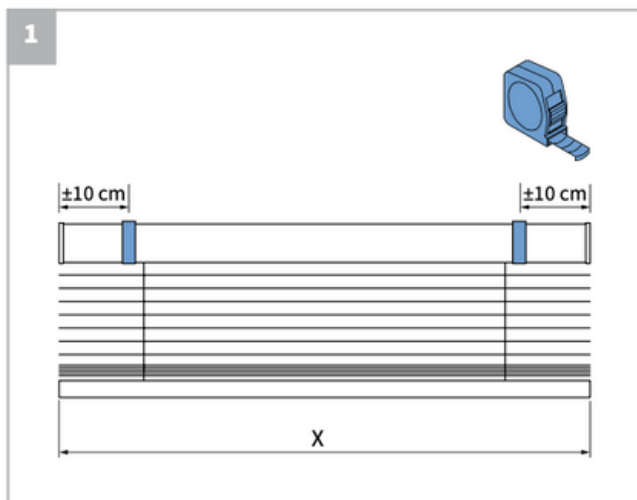

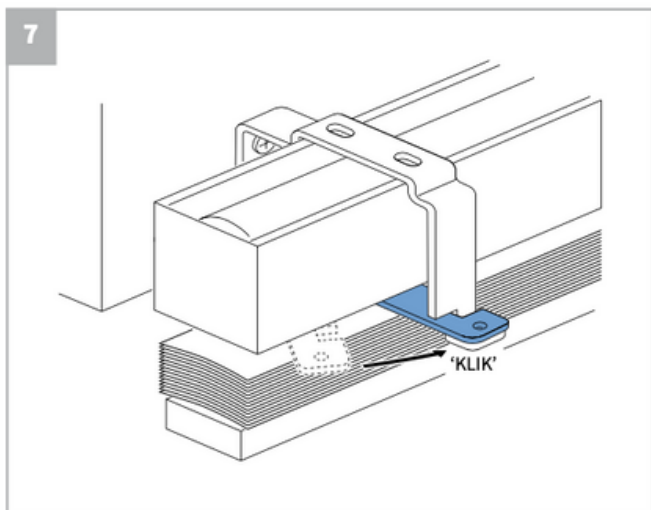

Koof houten jaloezieën

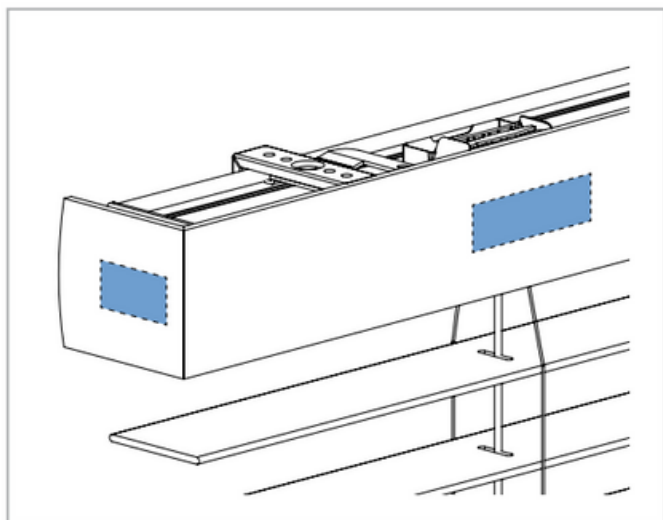
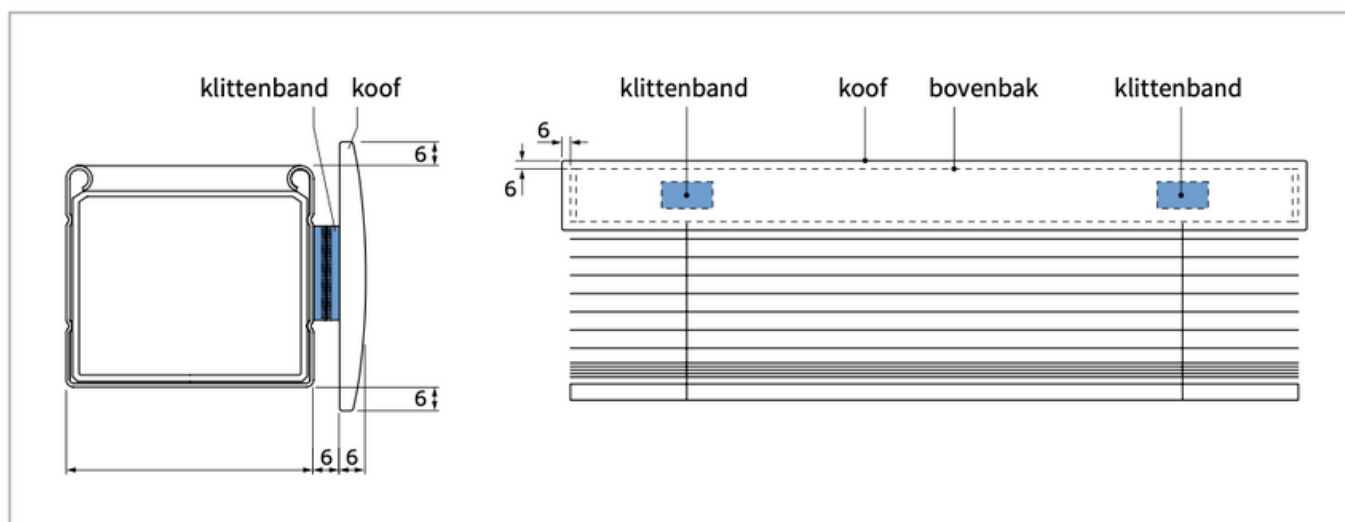

Zijgeleiding

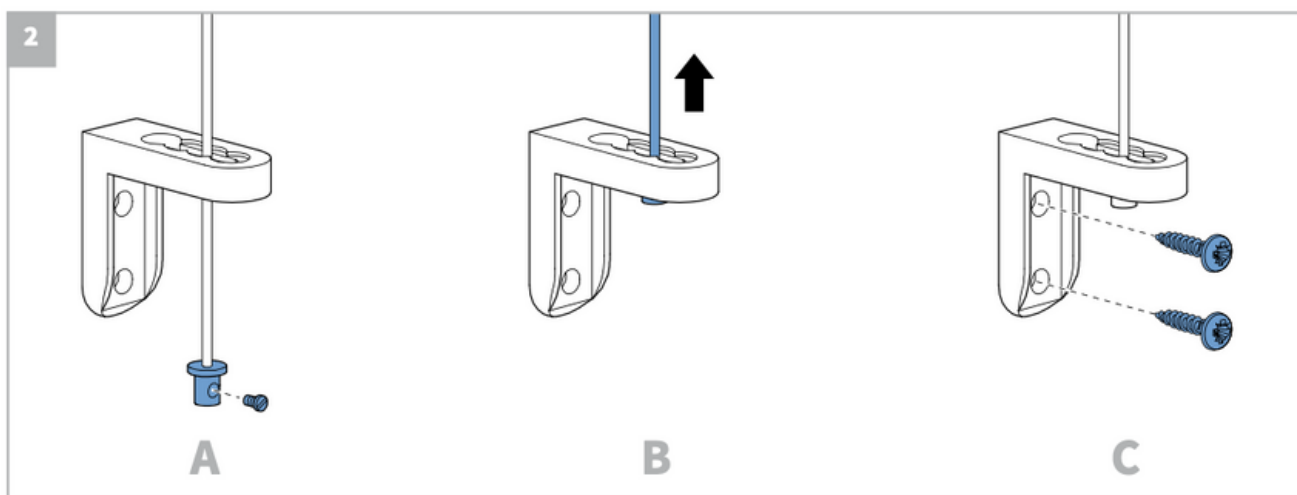
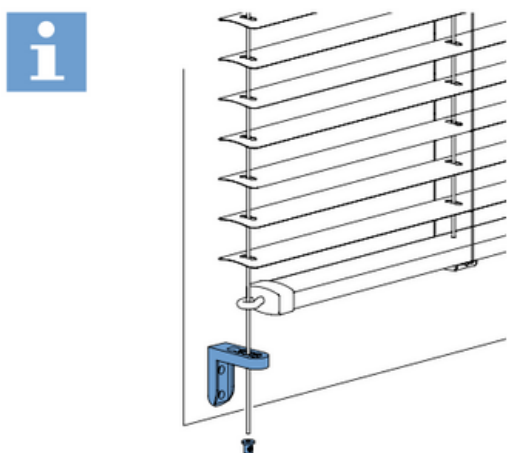
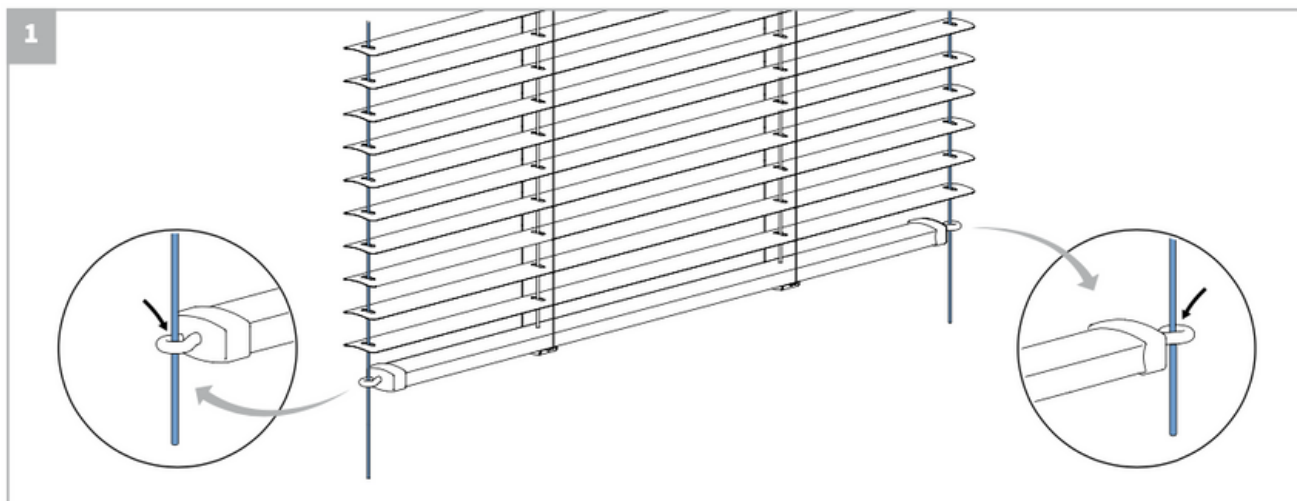

Zijgeleiding

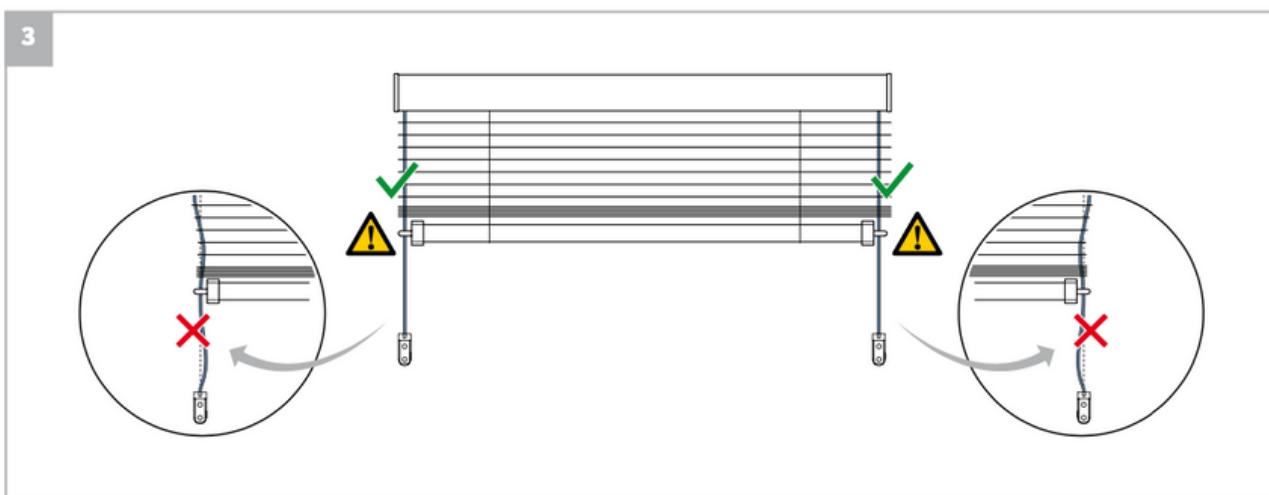
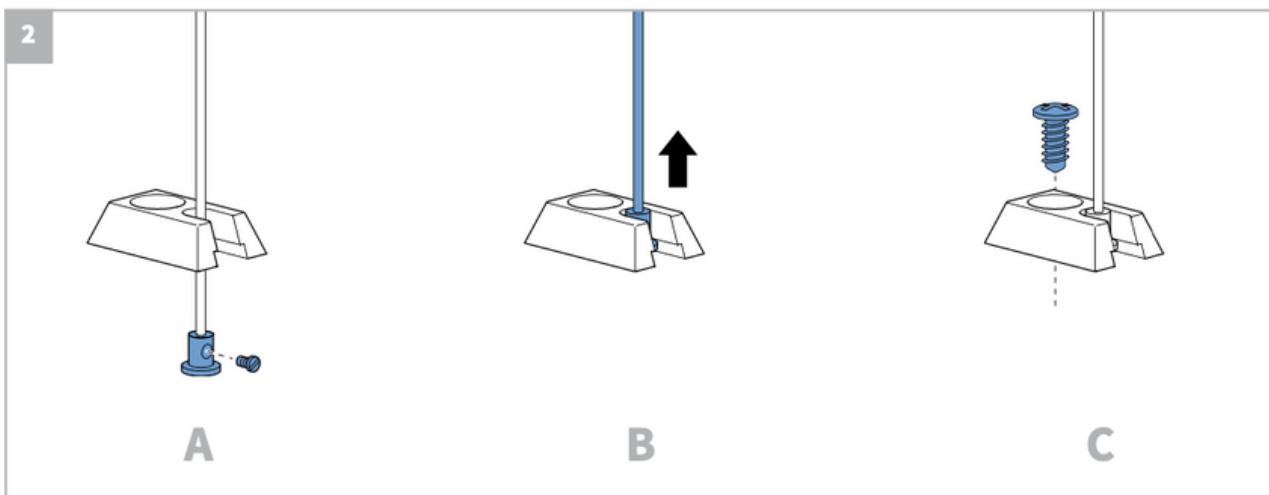
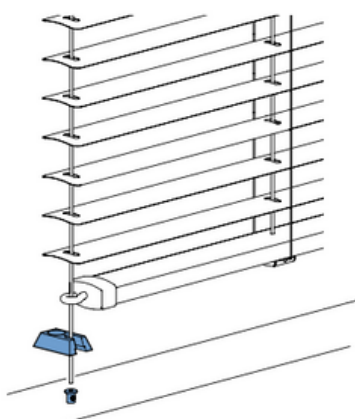

Top Down - Bottom Up

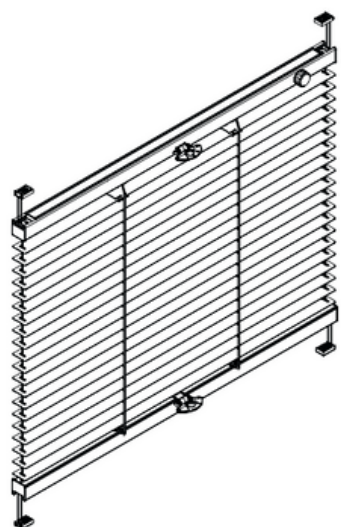

In de dag

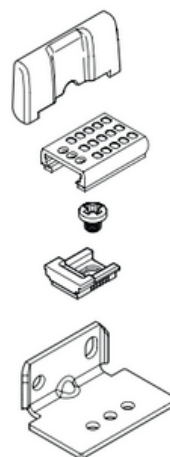

Op de dag

In de dag

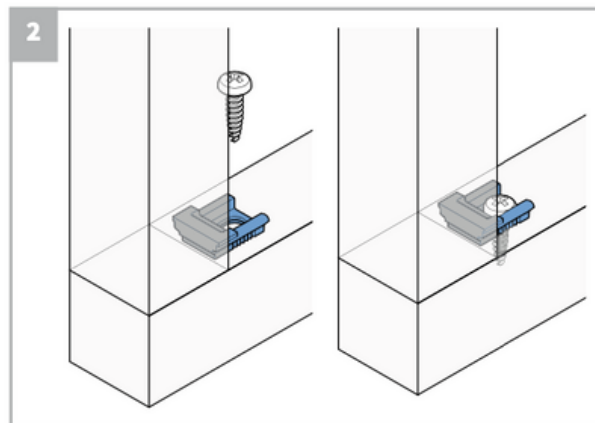
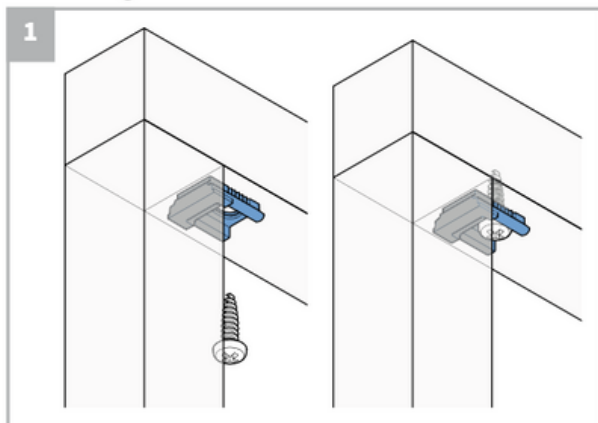

Op de dag

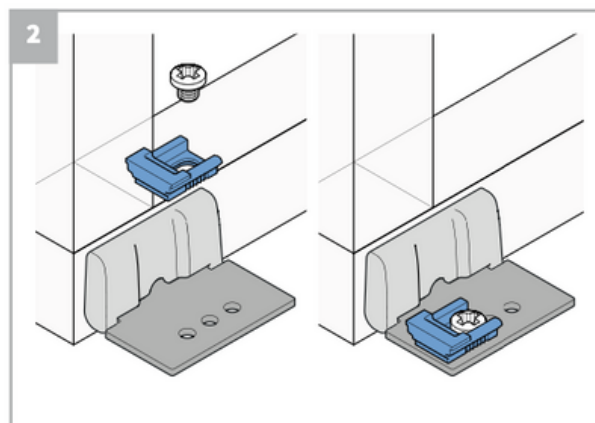
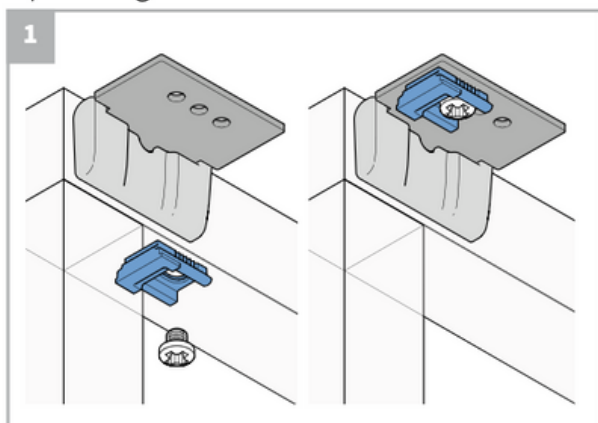

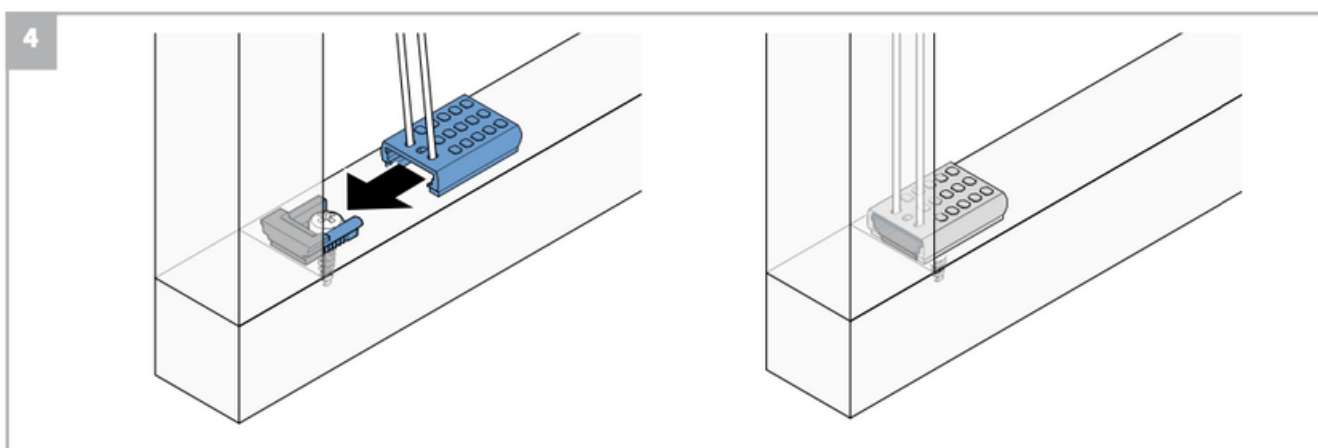
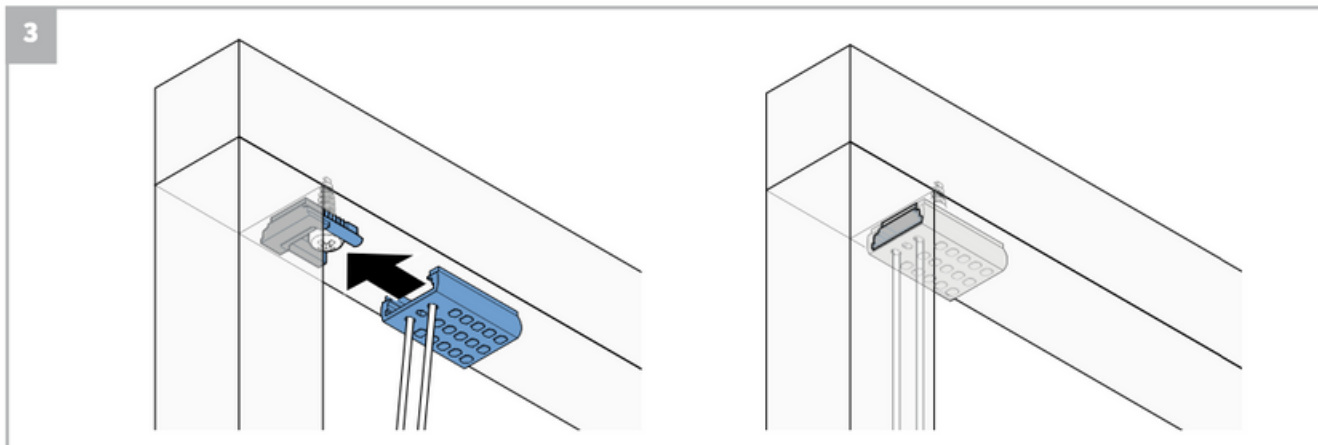

Bediening

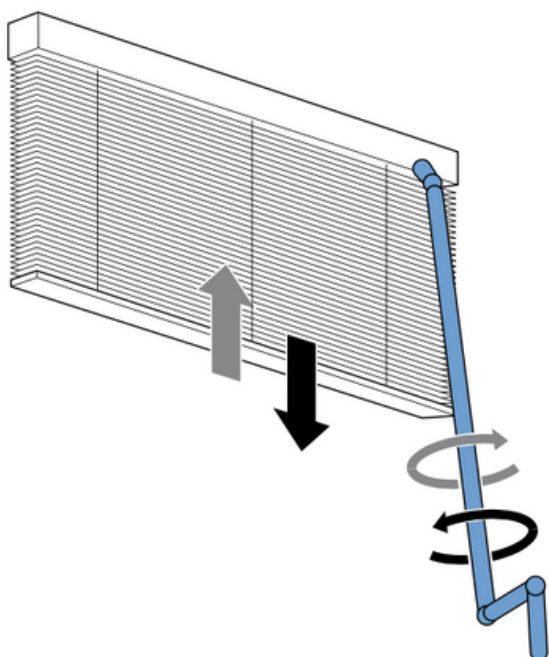
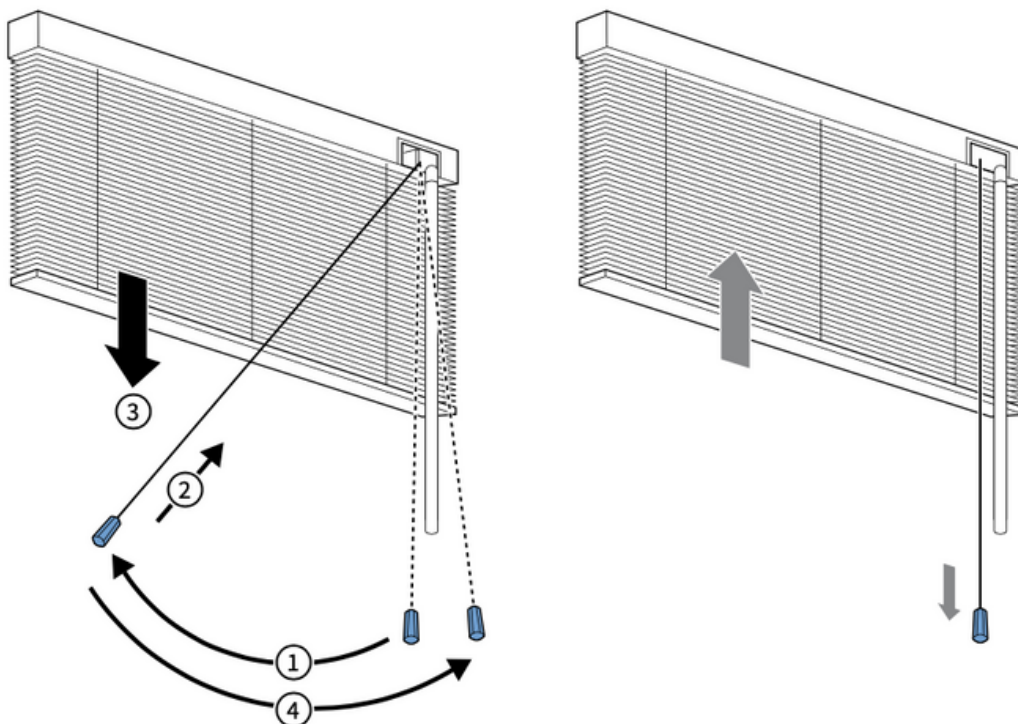

Elektrische bediening

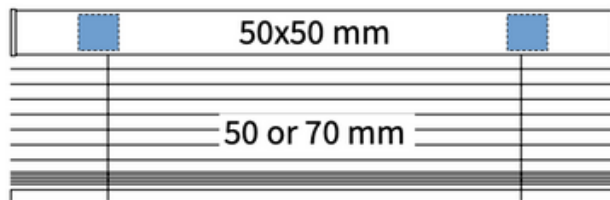

Let op bij montage!

1 Ladderkoord

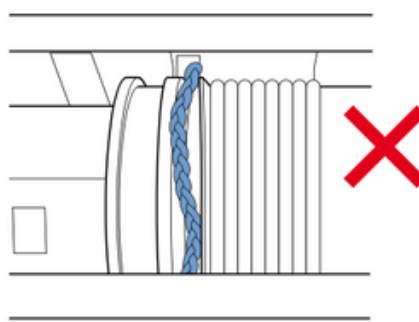
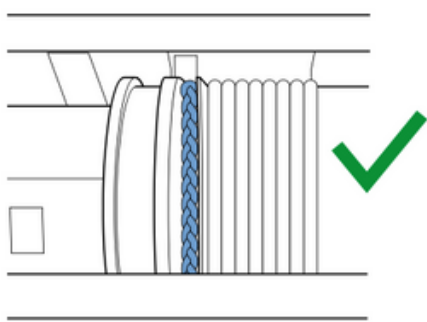

2 Lagerblok

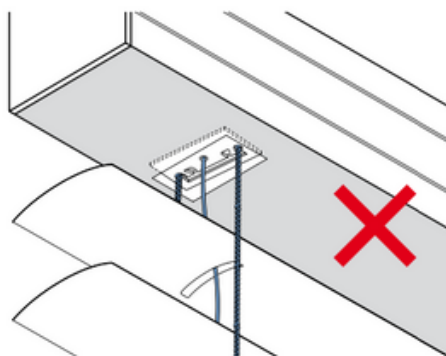
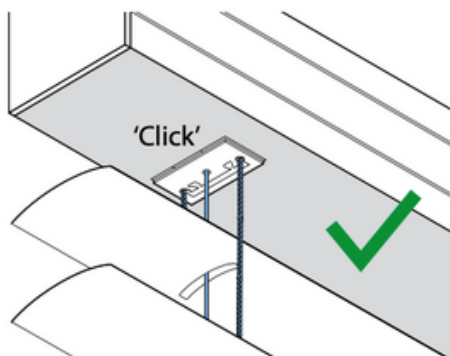

3 Optrekkkoord

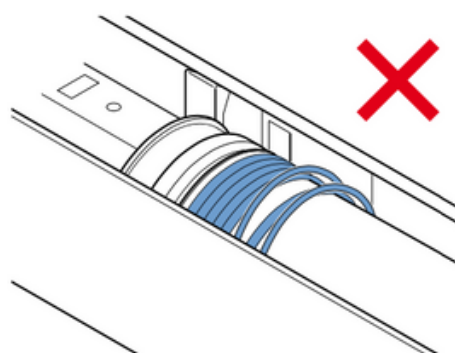
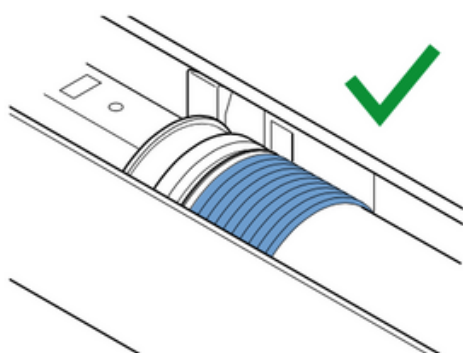



Let op bij bediening!

1 naar beneden

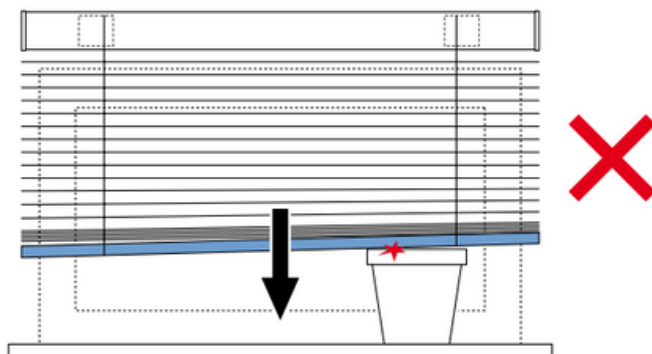

2 naar boven

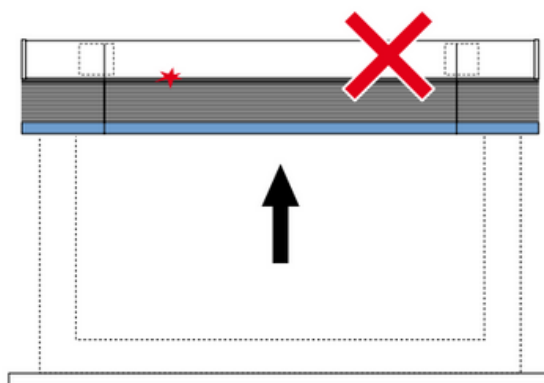
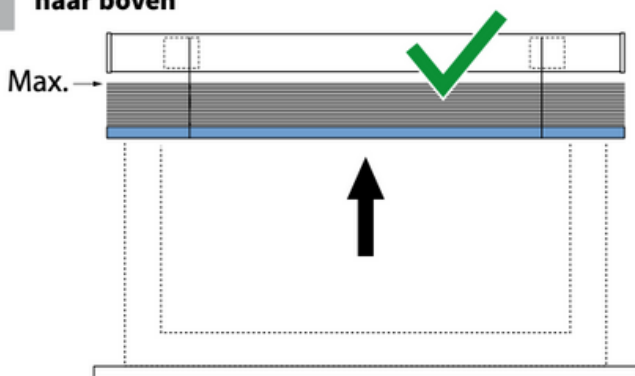

Afmetingen montagemateriaal



Beugel 35 - 50 - 70 mm

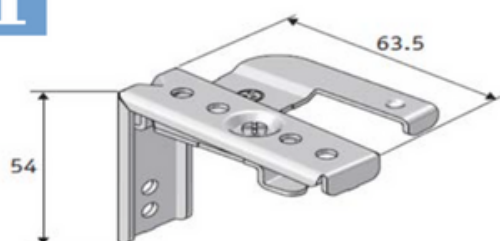

Zijsteun 50 mm

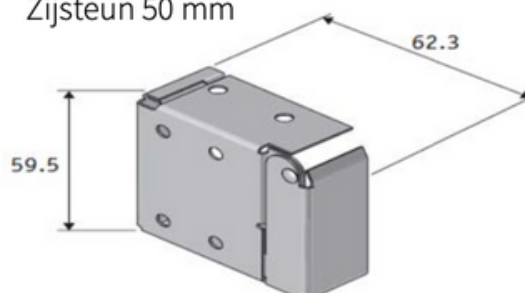

Tussensteun 50 mm

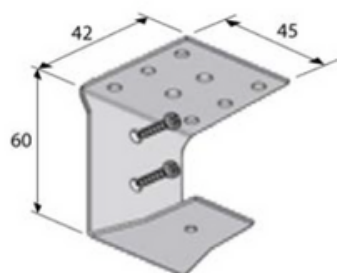

Koofsteun
bij elektrische bediening

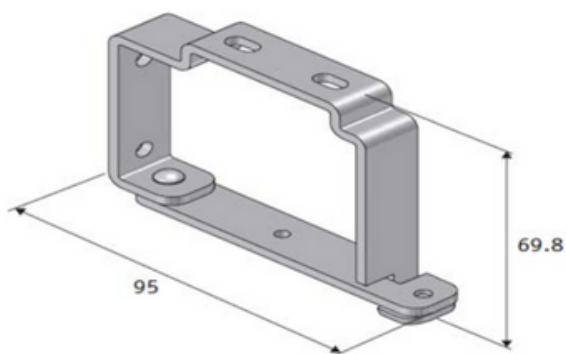

Klemsteun draai/kiepraam
25 mm bovenbak - bovenkant

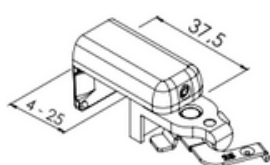

Klemsteun draai/kiepraam
50 mm bovenbak - bovenkant

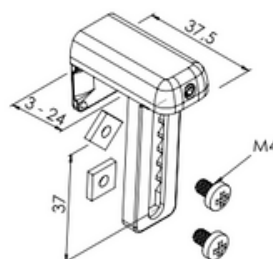

Klemsteun draai/kiepraam
25 mm onderkant

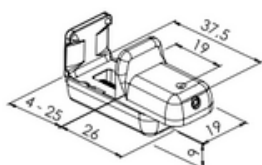

Klemsteunen set draai/kiepraam
50 mm onderkant

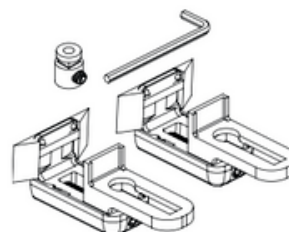

Kindveiligheid - Koordbediening

WAARSCHUWING

- Jonge kinderen kunnen gewurgd worden in de lus van trekkoorden, banden en koorden die binnenzonwering bedienen. Koorden kunnen ook rond de nek wikkelen.
- Houd koorden buiten het bereik van jonge kinderen, om wurging en verstrengeling te voorkomen.
- Houd meubels uit de buurt van binnenzonwering koorden.
- Knoop de koorden niet bij elkaar. Zorg ervoor dat de koorden niet kunnen draaien of een lus kunnen creëren.
- Installeer en gebruik de meegeleverde veiligheidsvoorzieningen volgens de installatie-instructies voor dit product om de mogelijkheid van een dergelijk ongeval te beperken.

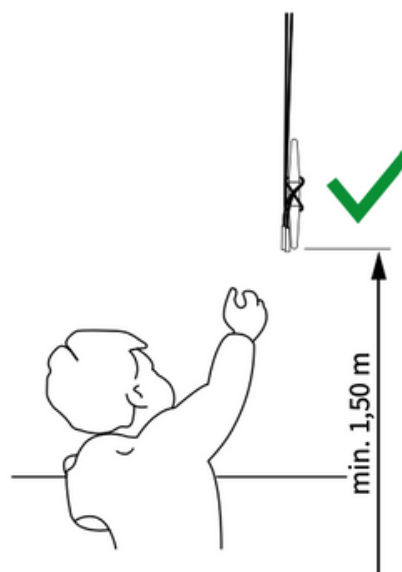
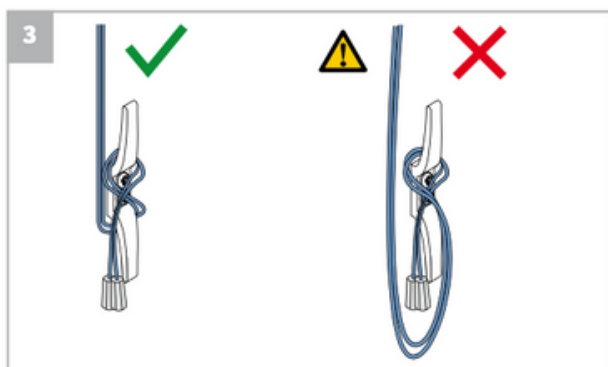
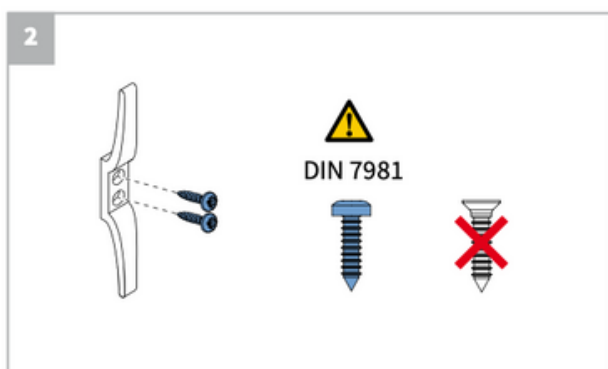
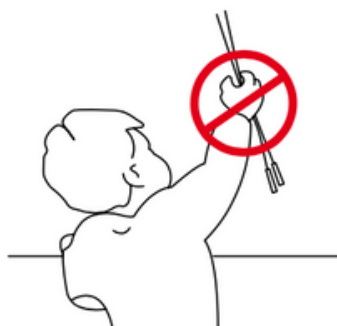
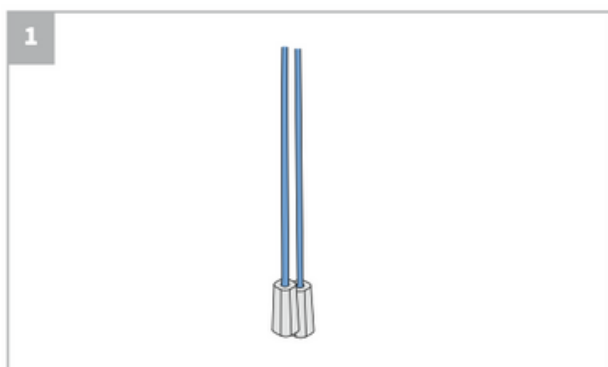

Kindveiligheid - Kettingbediening

